

Surf. au sol / Superf. interna netta/ Internal surface : 0,58 m²

Surf. hors tout / Superficie totale/ Total surface : 0,77 m²

Pente de toit/ Pendenza tetto/ Roof slope : 13 °

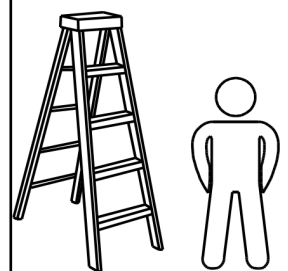

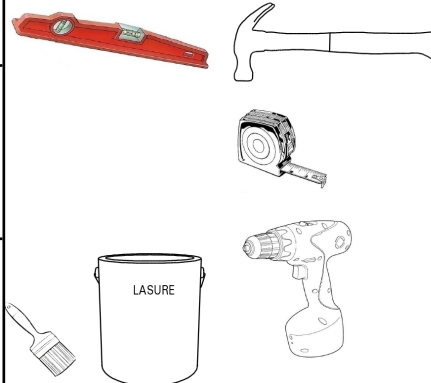
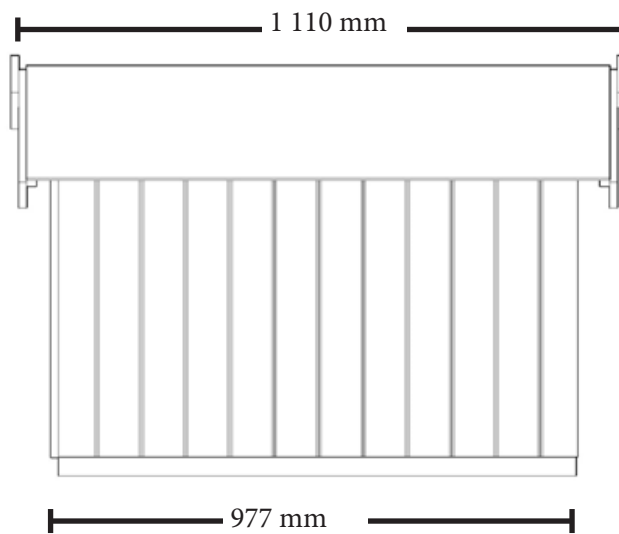
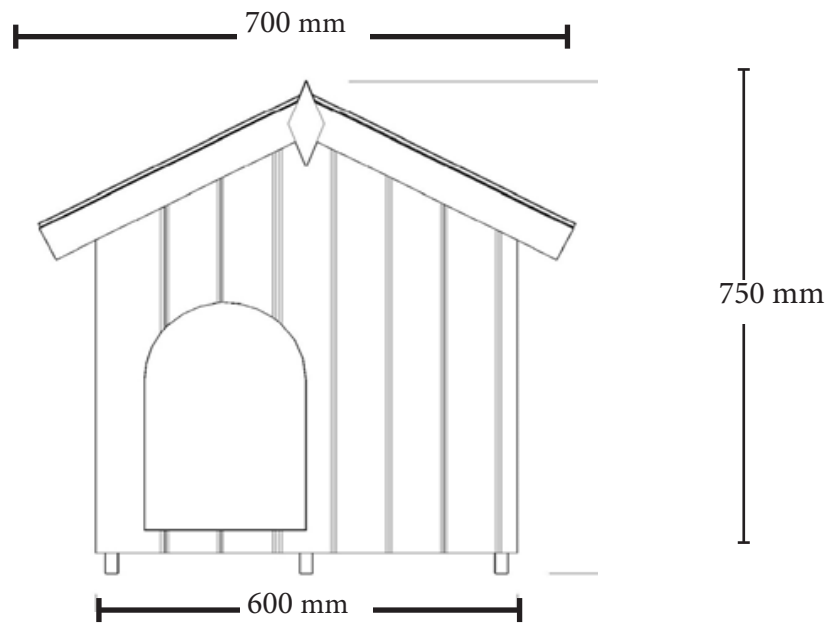



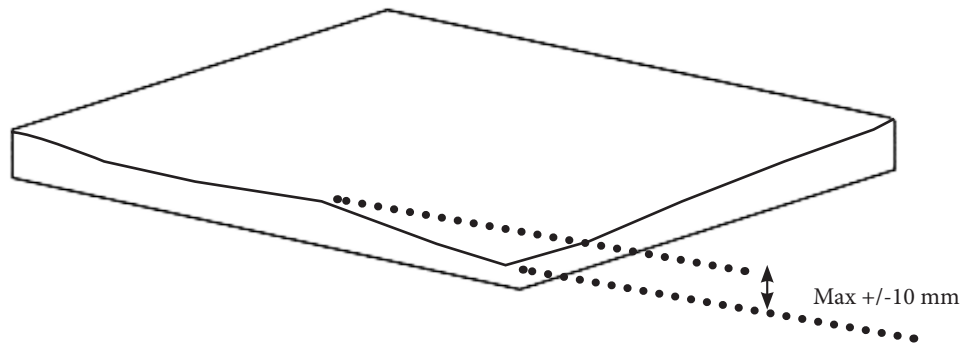
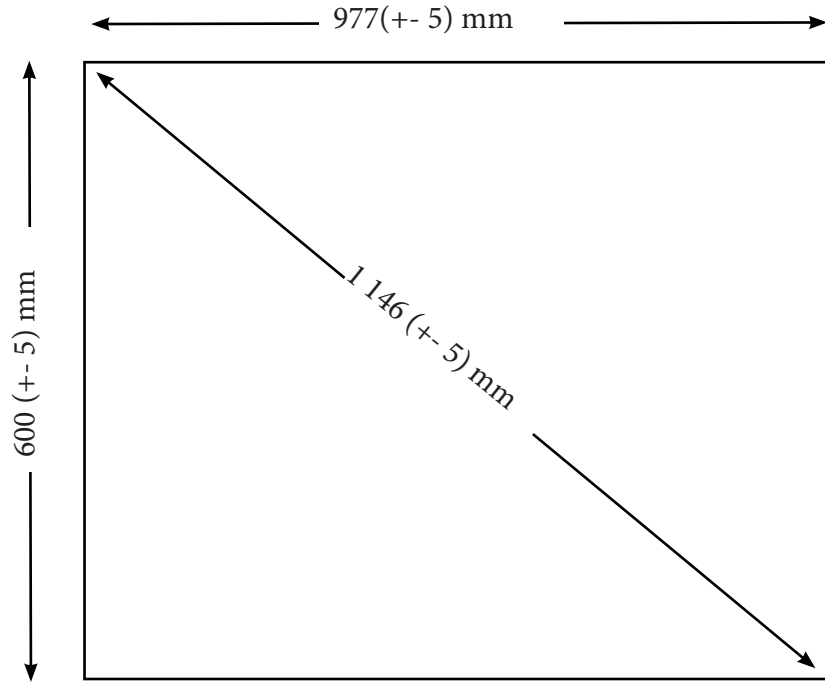

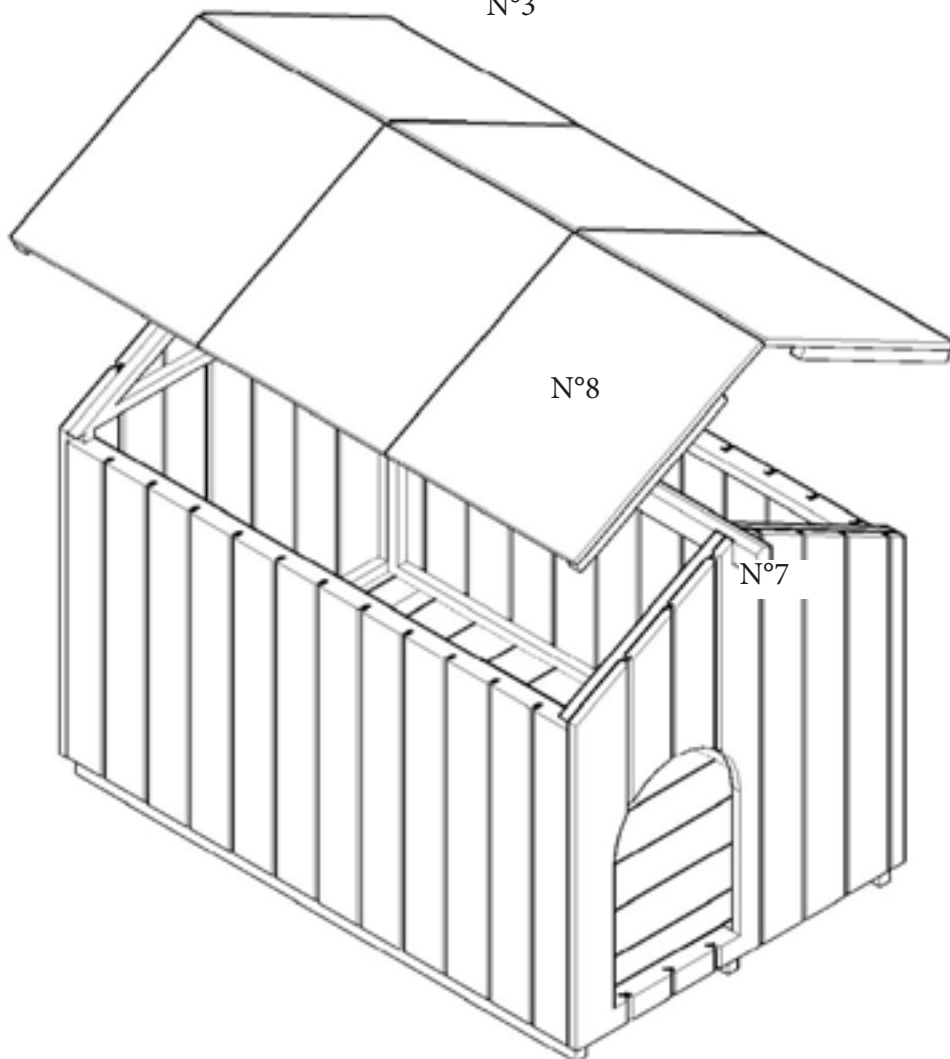
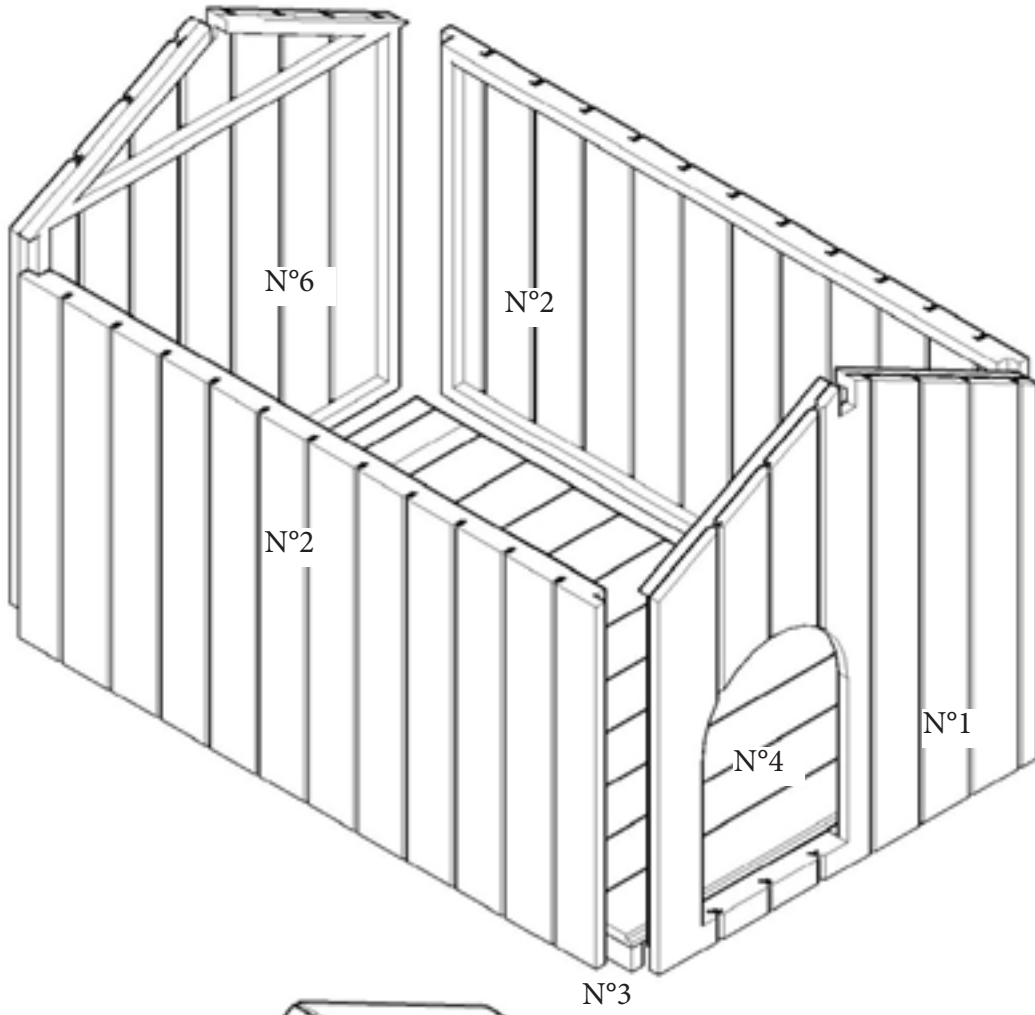







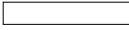
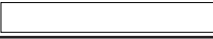

Plan de soubassement NC 0711.01
Piano di basamento NC 0711.01
Basement plan NC 0711.01





						Demande sav	
N°	REF	DES.	DIM (mm)	QTE		OBS	QTE
1	PF750.600		750X600X36	1+1			
2	PL 945.550		945X550X36	2			
3	GD945.40		945X40X20	3			
4	A565.16		565 X 95 X 16	10			
5	DSF430.60		430X60X16	4			
6	PS750.600		750X600X36	1			
7	GC1060.50		1060 X 50 X 30	1			
8	OSB420.353		420 X 353 X 12	4+2			
9	CAR 1100.1000		1100X1000 X 3	1			
10	R150.60		150X60X20	2			

Détail sachet de visserie/Bustina de feromento/Iron bag

28	Vis 4,0 x 45		4 x 45	8			
29	Clous L70			4			
31	Vis 3,0 x 30		3,0 x 30	40			
32	Clous L40		1,8 x 40	100			
33	Clous L16		90 x 60	50			
34	Vis 3,5 x 35		3,5x 35	8			

A compléter impérativement pour toute demande SAV et à envoyer par mail à sav@foresta.fr + photo des pièces abîmées (To be completed imperatively + Photo of damaged parts)

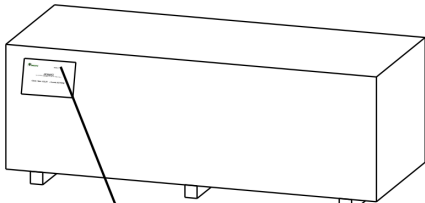
 <p>Colis n°: _____</p>	<p>NC 0711.01</p> <p><u>Colis(package) n° :</u></p>	MAGASIN (STORE)	
		NOM (NAME) CLIENT	
		PRENOM(PRE.) CLIENT	
		TEL. 